

1/2.9" SONY EXMOR CMOS 2.4MP
1080P HD-TVI/EX-SDI IR VANDAL DOME CAMERA
TRUE D&N (ICR)
2.8~12mm MP MOTORIZED AUTO-FOCUS LENS
DC12V/AC24V (AVC-VA92AVLT)
36 IR LED's
HEATER & THERMOSTAT
IP68 WATERPROOF RATING

Model No. AVC-VA92AVLT



Please read this manual carefully before installation and follow the instruction. Store this manual in a safe place for future reference. The manufacturer shall not be legally responsible for any product damage or personal injury caused by incorrect installation or operation. Product specifications and data are subject to change without notice to improve product reliability.

CONTENTS

1. CAUTIONS
2. PRECAUTIONS
3. FEATURES
4. ACCESSORIES
5. INSTALLATION GUIDE
6. DIMENSION
7. SPECIFICATIONS
8. OSD MENU
9. TROUBLESHOOTING
10. WARRANTY INFORMATION

CAUTION

We strongly recommend this product to be installed by qualified personnel only. To reduce the risk of electric shock do not perform any servicing other than that contained in the operating instructions unless you are qualified to do so.

Use Class 2 Power Supply Only

1. CAUTIONS

This device complies with Part 15 of the FCC Rules. Operation is subject to the following two conditions:

1. This device may not cause harmful interference.
2. This device must accept any interference received, including interference that may cause undesired operation

Note

This equipment has been tested and found to comply with the limits for a Class A digital device, pursuant to part 15 of the FCC Rules. These limits are designed to provide reasonable protection against harmful interference when the device is used in a residential area, and can radiate radio frequency energy and, if not installed and used in accordance with the instruction manual, may cause harmful interference to radio communications. Operation of this equipment in a residential area is likely to cause harmful interference in which case the user will be required to correct the interference at his own expense.

WARNING

This is a class A product. In a domestic environment this product may cause radio interference in which case the user may be required to take adequate measures

Caution

Any changes or modifications in construction of this device which are not expressly approved by the party responsible for compliance could void the user's authority to operate the equipment.

CAUTION

1. A regulated DC12V or AC24V power supply with a minimum of 500mA / 10VA is recommended for use with this product for the best picture and the most stable operation. An unregulated power supply can cause damage to the product.
2. It is recommended that cables and monitors with a 75ohm video impedance level are used with product.
3. Do not disassemble the camera to gain access to the internal components. Refer servicing to your dealer.
4. Pointing the camera directly towards the sun, or any similarly bright or reflective light, may cause smear and possible damage to the sensor.
5. Removing the Serial Number Label will void the warranty.
6. The camera's power supply must be plugged into a properly grounded wall socket.

1. CAUTIONS



WEEE (Waste Electrical & Electronic Equipment)

This marking shown on the product or its literature, indicates that it should not be disposed with other household wastes at the end of its working life. To prevent possible harm to environment or human health from uncontrolled waste disposal, please separate this from other types of waste and recycle it responsibly to promote the sustainable reuse of material resources. Household users should contact either the retailer where they purchased this product, or their local government office, for details of where and how they can take it for environmentally safe recycling.

Business users should contact their supplier and check the terms and conditions of the purchase contract.

This product should not be mixed with other commercial wastes for disposal.



CAUTION

RISK OF ELECTRIC SHOCK DO NOT OPEN



CAUTION : TO REDUCE THE RISK OF ELECTRIC SHOCK, DO NOT REMOVE COVER (OR BACK). NO USER SERVICEABLE PARTS INSIDE. REFER SERVICING TO QUALIFIED SERVICE PERSONNEL



This symbol is intended to alert the user to the presence of un-insulated "dangerous voltage" within the product's enclosure that may be of sufficient magnitude to constitute a risk of electric shock



This symbol is intended to alert the user to the presence of important operating and maintenance (servicing) instructions in the literature accompanying the appliance.

2. PEECAUTIONS

1. Do not install the camera near electric or magnetic fields.

Install the camera away from TV/radio transmitters, magnets, electric motors, transformers and audio speakers since the electromagnetic fields generated from these devices may distort the video image or otherwise interfere with camera operation.

2. Never disassemble the camera beyond the recommendations in this manual nor introduce materials other than those recommended herein. Improper disassembly or introduction of corrosive materials may result in equipment failure or other damage.

3. Try to avoid facing the camera toward the sun.

In some circumstances, direct sunlight may cause permanent damage to the sensor and/or internal circuits, as well as creating unbalanced illumination beyond the capability of the camera to compensate.

4. Keep the power cord away from water and other liquids and never touch the power cord with wet hands. Touching a wet power cord with your hands or touching the power cord with wet hands may result in electric shock.

5. Never install the camera in areas exposed to oil, gas or solvents.

Oil, gas or solvents may result in equipment failure, electric shock or, in extreme cases, fire.

6. Cleaning

For cameras with interchangeable lenses, do not touch the surface of the sensor directly with the hands. Use lens tissue or a cotton tipped applicator and ethanol to clean the sensor and the camera lens. Use a damp soft cloth to remove any dirt from the camera body. Please do not use complex solvents, corrosive or abrasive agents for cleaning of and part of the camera.

7. Do not operate the camera beyond the specified temperature, humidity or power source ratings. This camera is suitable for indoor operation only. Use the camera at temperatures within $-40^{\circ}\text{C}\sim 60^{\circ}\text{C}$ ($-40^{\circ}\text{F}\sim 140^{\circ}\text{F}$) and humidity between 20% and 80%. This device is not rated as submersible. The input power source is 12VDC/24VAC regulated.

8. Mounting

Use care in selecting a solid mounting surface which will support the weight of the camera plus any wind, snow, ice or other loading, and securely attach the camera to the mounting surface using screws and anchors which will properly support the camera. If necessary (e.g. when mounting to drop ceilings) use a safety wire to provide additional support for the camera.

3. FEATURES

- 1/2.9" SONY EXMOR CMOS 2.4MP
- 1080P HD-TVI/EX-SDI IR VANDAL DOME CAMERA
- TRUE D&N (ICR)
- 2.8~12mm MP MOTORIZED AUTO-FOCUS LENS
- DC12V/AC24V (AVC-VA92AVLT)
- 36 IR LED's
- HEATER & THERMOSTAT
- IP68 WATERPROOF RATING



4. ACCESSORIES

1

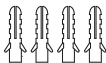

1. Drywall / Concrete Anchor x 4

2



2. Mounting Screw x4

3



3. L-Wrench / L-Wrench

4



4. Rubber Base Cap

5



5. Holder Cable x 2

6

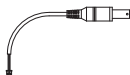

6. Test Video Cable

7

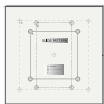

7. Screw Hole Template

8



8. Owner's Manual

5. INSTALLATION GUIDE

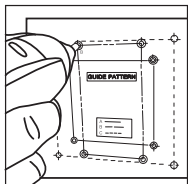

1. Drill 3/16" holes (4X) where indicated "B"

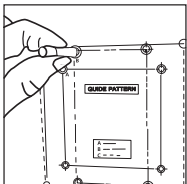

2. Firmly insert included drywall / concrete anchors

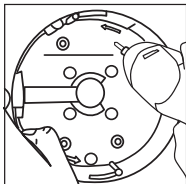

3. Align the bracket holes and tighten all 4 screws

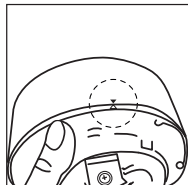

4. Position the camera to where it marked.

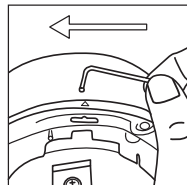

5. Turn the camera counter clock wise and tighten 2 lock screws, (Both sides)

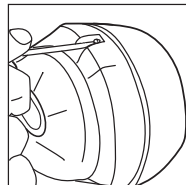

6. Install top cover and tighten all 3 screws

6. DIMENSION

Unit : mm (Inch)

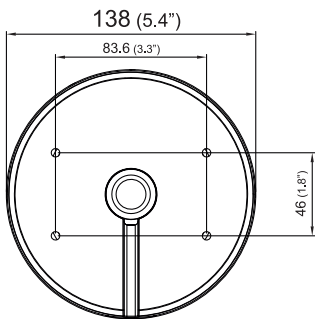
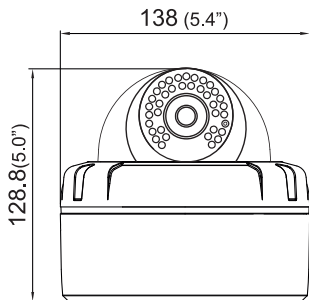

7. SPECIFICATIONS

IMAGE SENSOR	1/2.9" 2.4Megapixel Sony Exmor CMOS
EFFECTIVE PIXEL	2000 (H) × 1121(V)
SCANNING SYSTEM	PROGRESSIVE
VIDEO OUTPUT	CVBS : 1.0Vp-p, 75Ω composite
	TVI & SDI(1080P(30P)/ 720P(30P)/ 720 CROP(60P)
S/N (Y Signal)	More than 52dB
Min. ILLUMINATION	0.02Lux (SENS-UP x32)
IRIS ADJUSTMENT	ALC/ELC
LENS	2.8-12mm MP Motorized Auto-Focus Lens (ICR)
ELECTRONIC SHUTTER	NTSC : OFF/AUTO/FLK/MANUAL(1/30 ~ 1/30,000)
	PAL : OFF/AUTO/FLK/MANUAL(1/25 ~ 1/25,600)
OSD LANGUAGE	ENG/CHN/CHN[S]/JPN/KOR
BACKLIGHT COMPENSATION	OFF /HLC/BLC/WDR
WHITE BALANCE	AUTO/AUTOext/PRESET/MANUAL
DAY & NIGHT	COLOR/B&W/EXTERN/AUTO
Auto Gain Control	LEVEL(0~10)Adjustment
PRIVACY MASKING	On / Off (Programmable 16 zones)
DNR	OFF / LOW / MIDDLE / HIGH
ACE	OFF / LOW / MIDDLE / HIGH
DEFOG	OFF / LOW / MIDDLE / HIGH
SENS-UP	OFF/ X2~X32
MOTION DETECTION	4 AREA
DIGITAL EFFECT	OFF/MIRROR/FLIP
DEFECT	LIVE DPC
COMMUNICATION	UTC
IR LED	36pcs
INPUT VOLTAGE	DC 12V(±10%) / AC 24V DUAL VOLTAGE
Heater Operation Specification	THE INTERNAL TEMPERATURE, OFF : 20° / ON : -20°
Power Consumption	HEATER OFF DC IR OFF : 150mA (MAX) / DC IR ON : 400mA (MAX)
	HEATER ON DC IR OFF : 250mA (MAX) / DC IR ON : 500mA (MAX)
	HEATER OFF AC IR OFF : 180mA (MAX) / AC IR ON : 360mA (MAX)
	HEATER ON AC IR OFF : 280mA (MAX) / AC IR ON : 460mA (MAX)
OPERATING TEMP. / HUM.	-10.0℃ ~ +50.0℃ / MAX 90% RH
STORAGE TEMP. / HUM.	-20.0℃ ~ +60.0℃ / MAX 90% RH

※ This device complies with part 15 of the FCC Rules. Operation is subject to the following two conditions : (1) This device may not cause harmful interference, and (2) this device must accept any interference received, including interference that may cause undesired operation.

8. OSD MENU

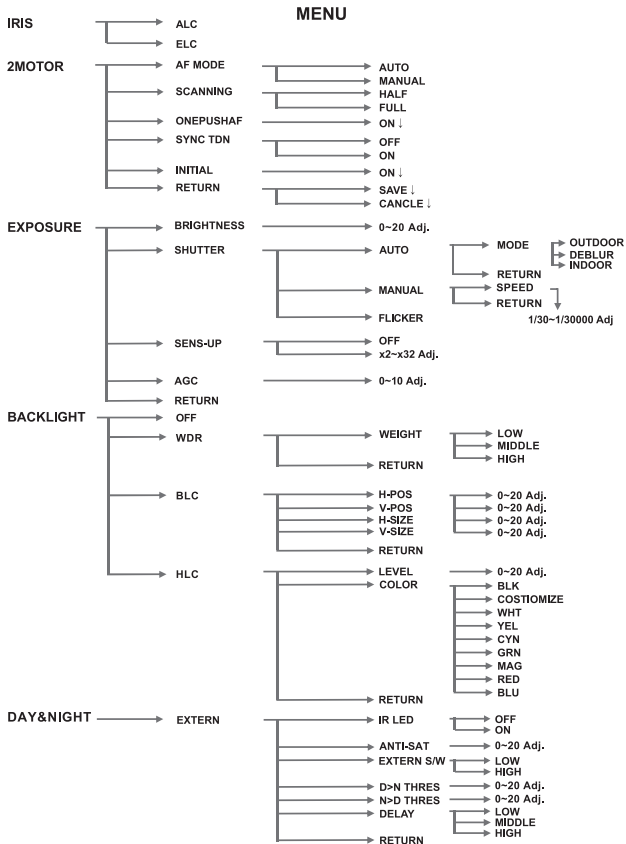

8. OSD MENU

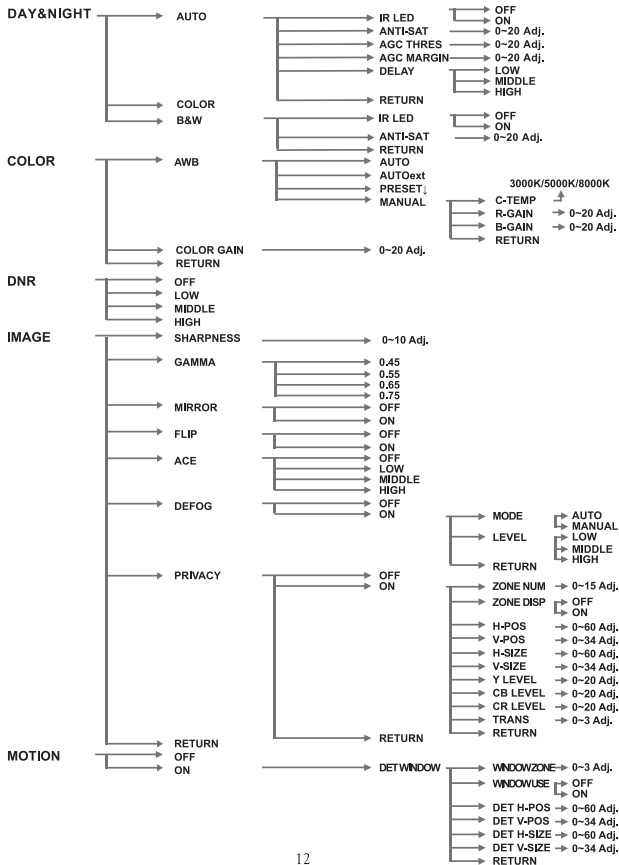

8. OSD MENU

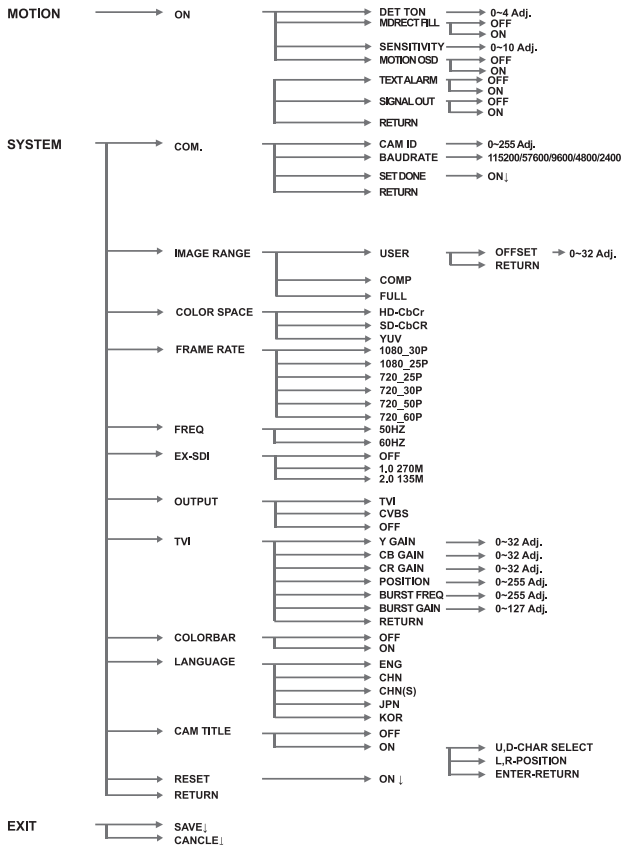

9. TROUBLESHOOTING

Problem	Solution
No Image	<ul style="list-style-type: none">• Check if the power cord and line connection between the camera and monitor are connected properly
Image is too dim	<ul style="list-style-type: none">• Remove protective film• If window is dirty, clean the lens with soft clean cloth
Image flickers	<ul style="list-style-type: none">• Change the camera angle so the camera is not facing directly to the sunlight or fluorescent light
Contrast is too low	<ul style="list-style-type: none">• Adjust the contrast• Change the camera angle so the camera is not facing directly to the sunlight or fluorescent light

10. WARRANTY INFORMATION

- Our professional video products are manufactured to the highest quality standards. Our product warranty and industry leading service and support ensure years of peace of mind usage to your business.
- Our product warranty will cover both parts and labor at no additional cost with in our standard warranty period. However, our warranty does not cover camera which has been misused, tampered with, modified or damaged as a result of accident, installation error, impact or lack of proper care.

AVYCON
WWW.AVYCON.COM